

  +966 56 642 8459

 info@rth.sa

 www.rth.sa

JK 104

E 450x450x225

I 400x400x205

H ϕ 114

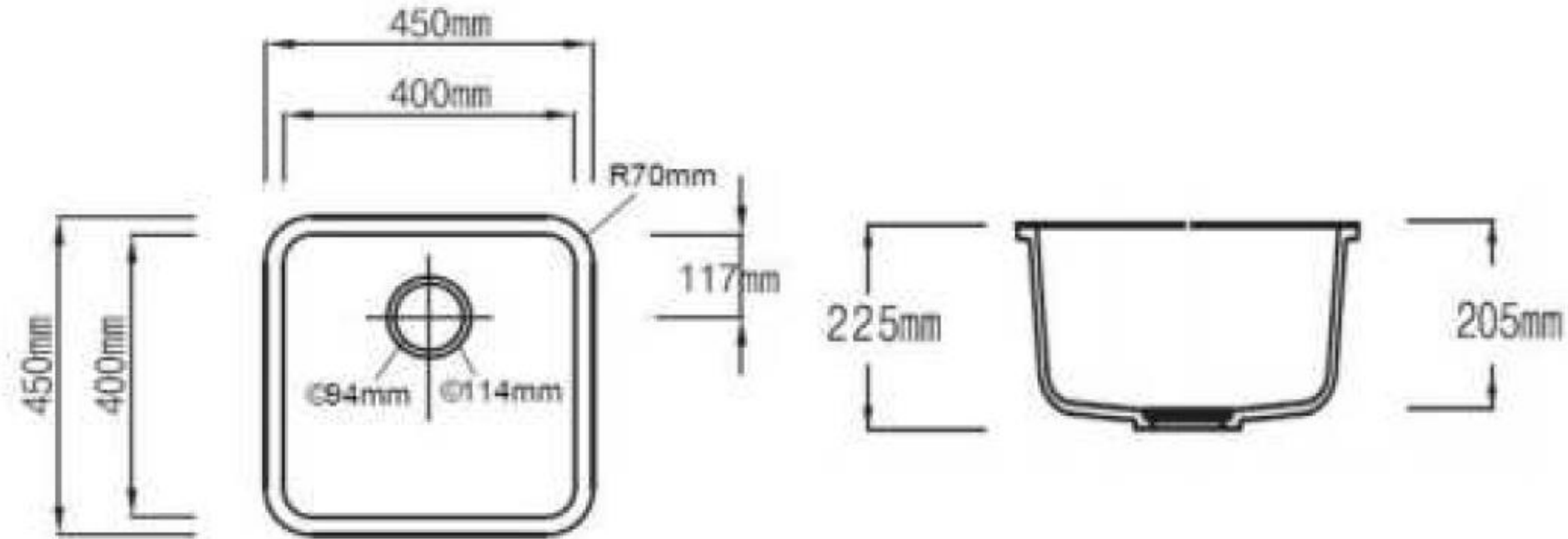

E: external size / I: internal size / H: hole size

Color: white/ivory available

  +966 56 642 8459

 info@rth.sa

 www.rth.sa

Test Results					
TEST ITEM	UNIT	SAMPLE	RESULT	TEST METHOD	
Specific Gravity((23/23) °C)	-	-	1.70	ASTM D792-13(Method A)	
Rockwell Hardness(HRM)	-	-	82	ASTM D785-08(2015)(Procedure A)	
Barcol Hardness	-	-	61	ASTM D2583-13a	
Tensile Strength	MPa	-	50.1	ASTM D638-14(*)	
Flexural Strength	MPa	-	75.7	ASTM D790-17(**)	
Izod Impact Strength	J/m	-	19	ASTM D256-10e1(Method A)	
Water Absorption(24 h Immersion)	%	-	0.03	ASTM D570-98(2018)	
Appearance(Crack) after Heat Resistance[(170±2) °C×1 h]	-	-	No Defects	Client Provided Test Method	
Appearance(Discoloration) after Hot Water Resistance	-	-	No Defects	Client Provided Test Method(***)	
Deflection Temperature Under Load(1.82 MPa)	°C	-	98	ASTM D648-18(Method B)	
Thermal Expansion	1/°C	-	5.0×10 ⁻⁶	KS M 3015 : 2003	
Pencil Hardness(Mitsu bishi pencil)	-	-	6H	KS M ISO 15184 : 2013	

* Specimen : Type III , Speed of Testing : 5 mm/min
 ** Speed of Testing : 5.0 mm/min, Support Span : 190 mm
 *** Changing appearance after pour boiled water on the surface
 - Usage of Report : QUALITY CONTROL